

OPERATOR'S MANUAL



TOWBAR

MOTOR VEHICLE

OCT
1972

WARNING

TO AVOID DAMAGE OR INJURY



- ◆ NEVER ATTEMPT TO HOOK UP THE TOWBAR ALONE,
(USE TWO PEOPLE) .
- ◆ NEVER USE THE TOWBAR WITHOUT THE CLEVISES.
- ◆ TENSION ADJUSTING NUTS MUST BE TIGHT,
USE A WRENCH.

TOWING IS SERIOUS BUSINESS

WARNING

TO AVOID DAMAGE OR INJURY

- ◆ THE M715 OR M725, 1-1/4 TON VEHICLES CANNOT BE TOWED USING THIS TOWBAR. THESE VEHICLES MUST BE LIFT TOWED BY A WRECKER IN ACCORDANCE WITH FM 20-22 (JULY 1970), PARAGRAPH 90 b. "VEHICLE RECOVERY OPERATIONS".

TOWING IS SERIOUS BUSINESS

WARNING

TO AVOID **DAMAGE** OR **INJURY**
~~~~~

- ◆ WHEELED VEHICLES UP TO AND INCLUDING 14,000 LBS GROSS WEIGHT CAN BE TOWED WITH ALL WHEELS ON THE GROUND WITH THE TOWBAR IN ANY POSITION WHEN CONNECTED TO THE BUMPER SHACKLE BRACKETS. IT IS DESIRABLE TO KEEP THE TOWBAR EXTENSION AS CLOSE TO THE RETRACTED POSITION AS POSSIBLE.

# WARNING

TO AVOID DAMAGE OR INJURY



◆ WHEELED VEHICLES UP TO AND INCLUDING 42,000 LBS GROSS WEIGHT CAN BE TOWED WITH ALL WHEELS ON THE GROUND WITH THE TOWBAR IN THE RETRACTED POSITION WHEN CONNECTED TO THE BUMPER SHACKLE BRACKETS.

THIS ALLOWS TOWING OF ALL WHEELED VEHICLES UP TO AND INCLUDING EMPTY 5 TON TRUCKS. DO NOT EXCEED A SPEED OF 20 MPH OVER PRIMARY AND SECONDARY ROADS. THE 42,000 POUND GROSS WEIGHT LIMIT CAN BE APPLIED TO ANY LOADED VEHICLE THAT DOES NOT EXCEED 42,000 POUNDS GROSS WEIGHT.

# JUST THE FACTS ON:

## THE **MOTOR VEHICLE**

(FSN 4910-735-6056)



TOWING CAPACITY —————> Extended - 14,000 Lbs gross weight  
Retracted - 42,000 Lbs gross weight

MAXIMUM LEG EXTENSION —————> 81 INCHES

MINIMUM LEG EXTENSION —————> 53 INCHES

LEG SPREAD —————> 37 INCHES

WEIGHT —————> 165 LBS

VOLUME —————> 3.3 CUBIC FEET

# EVERY TOWBAR COMES FULLY

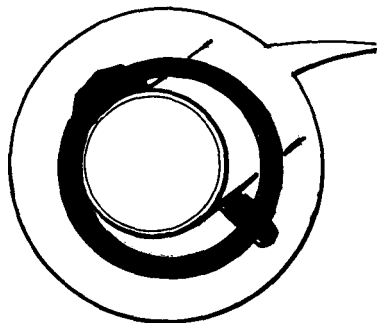

SAFETY PINS  
( 9 of 'em )

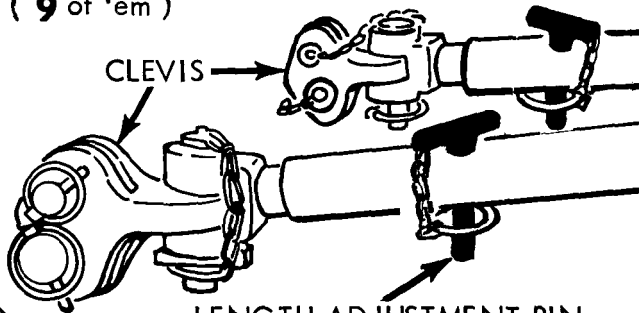

CLEVIS

LENGTH ADJUSTMENT PIN  
FSN 4910-147-2101 (2)

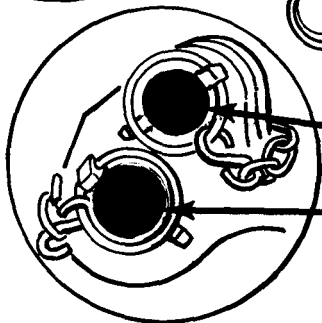

UP TO 3/4 TON LINKING PIN  
FSN 4910-147-2104 (2)

UP TO 5 TON LINKING PIN  
FSN 4910-147-2102 (5)

**YOU SUPPLY** DISABLED

# EQUIPPED WITH THE FOLLOWING:

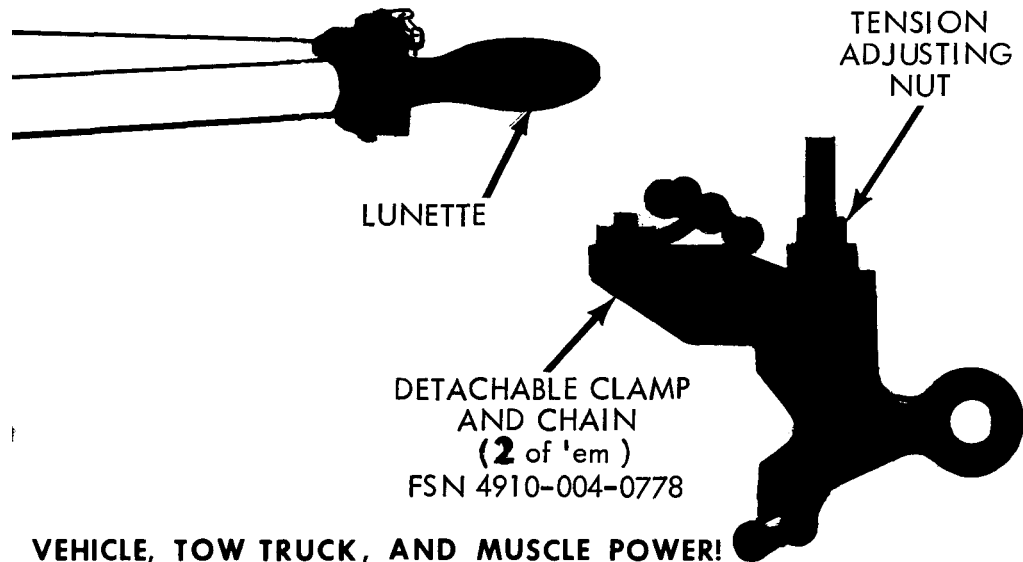



# OPERATING

# YOUR TOWBAR 3 WAYS

- 1) By coupling onto bumper shackle brackets.

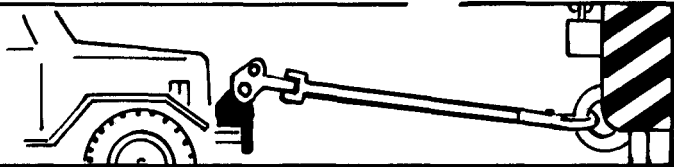

- 2) By attaching clamps and chains of towbar to front axle for lift tow operations.

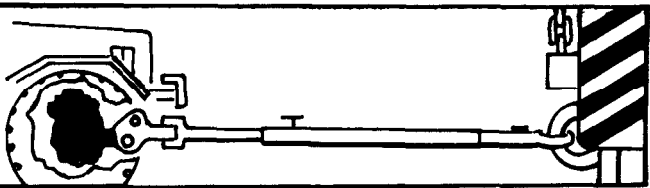

- 3) By using clamps and chains on bumper.

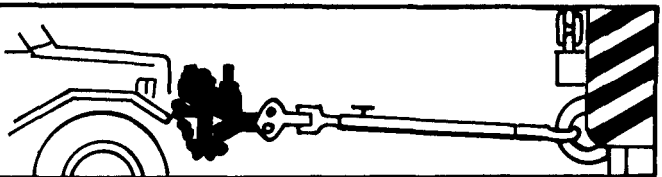

# 1 BRACKET TOWING

If your disabled vehicle has bumper shackle brackets (and steering, transmission, and front tires are O. K.) tow by coupling into brackets.

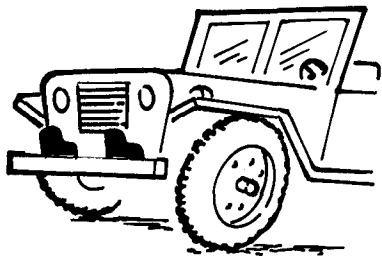

HERE'S HOW:



FIRST- Remembering that two are better than one, get a buddy to steer the disabled vehicle. Two drivers make the towing job **QUICKER, EASIER, and SAFER!**

SECOND- Select the linking pins you'll want to use, then couple onto bumper shackle brackets.

MORE  9

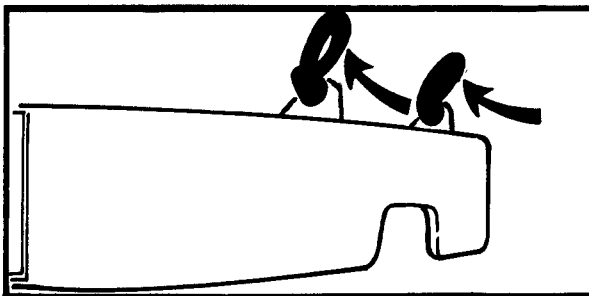

Remove towing pins and lifting shackles from brackets and set them aside. They won't be used.

YOUR HOOK-UP SHOULD LOOK LIKE THIS ON THE 5 TON TRUCK

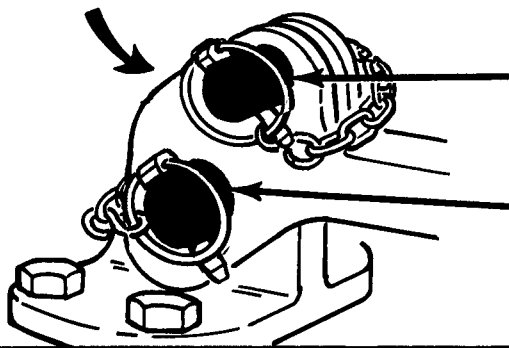

3/4 inch linking pin (smaller) is used for vehicles up to 3/4 ton.

1 inch linking pin (larger) is used for vehicles over 3/4 ton, including 5 ton.

## TWO RULES TO REMEMBER HERE:

- 1) The linking pin you're using will **ALWAYS** be on the **BOTTOM**.
- 2) The **TOP** of the "T" of length adjustment pin is **ALWAYS** on **TOP**.

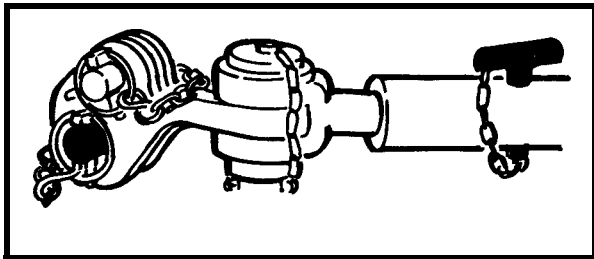

Rotate leg extension  
and clevis 180°

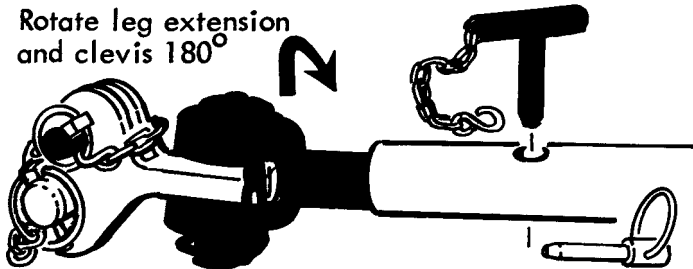

Presto !!

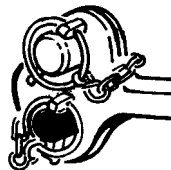

After clevises are connected to bumper shackle brackets attach lunette to the tow truck pintle.

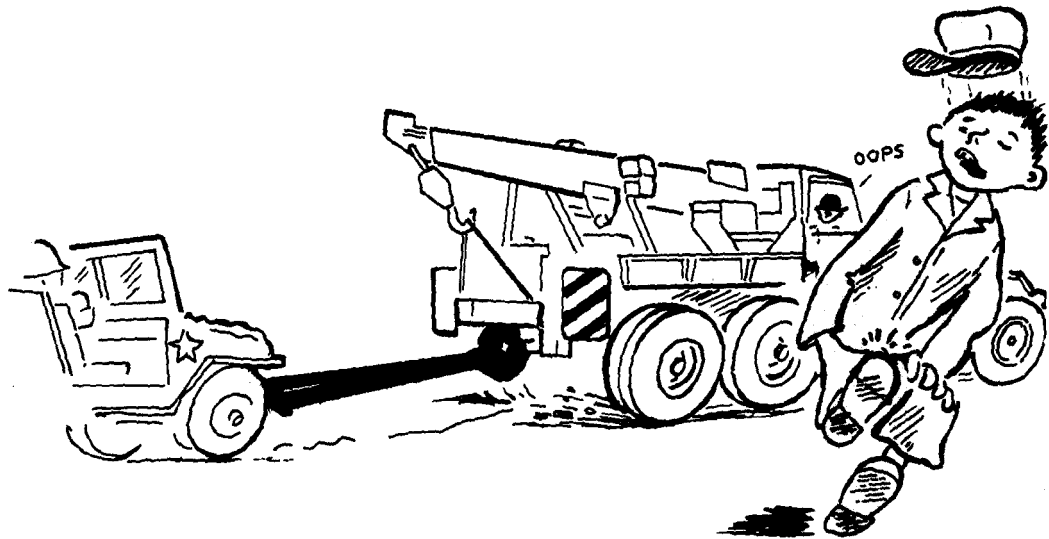

**THE TOWBAR IS ALWAYS ATTACHED TO TOW TRUCK LAST!!**  
**BACK the truck CAREFULLY and watch your toes !**



## DANGER

Be certain you have the proper linking pins in the clevis holes and always be sure your 9 safety pins are properly secured. (They snap shut automatically.)

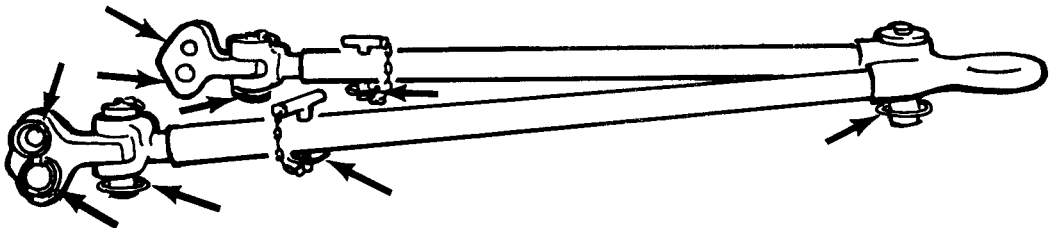

NOTE: PLIERS MAY BE NEEDED TO REMOVE SAFETY PINS.

SHOULDER

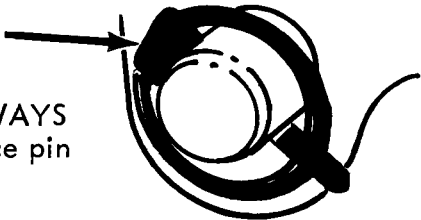

The shoulder of pin ALWAYS faces AWAY from surface pin lies against.

IT ONLY goes in ONE way!!

Use only the equipment -- including safety pins-- that comes with your TOWBAR. Don't interchange linking pins, safety pins, etc., from your vehicles with those of your TOWBAR.

## TOWBAR EXTENDED:

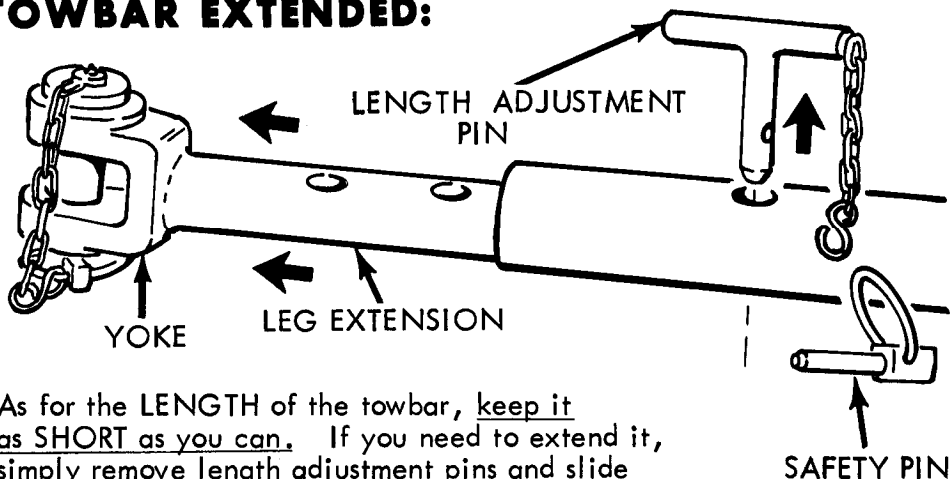

As for the LENGTH of the towbar, keep it as SHORT as you can. If you need to extend it, simply remove length adjustment pins and slide out leg extensions.

Whatever you do, don't use your TOWBAR without the CLEVISES !

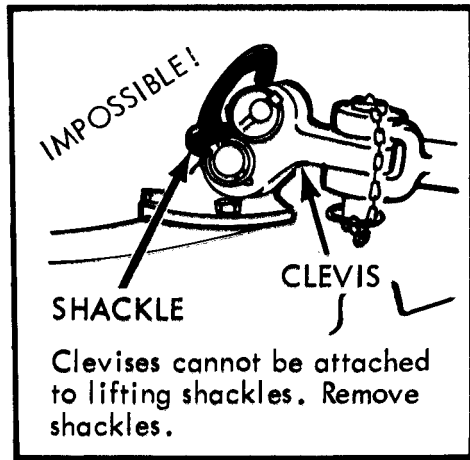
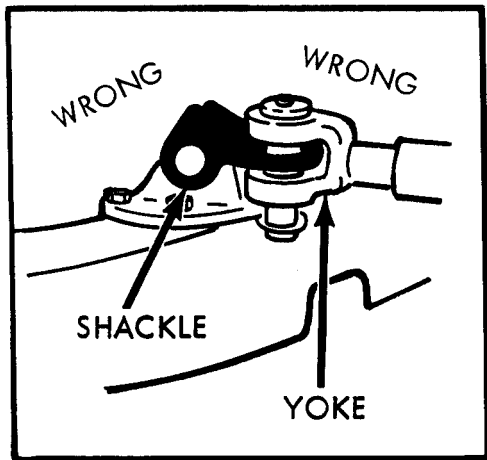

Hook it up right, or the results could be **DISASTROUS ! !**

**THERE IS A LIST OF IMPORTANT WARNINGS AT THE FRONT OF THIS MANUAL.**



*When  
You're  
Through*

First, un-hook towbar's  
lunette from tow truck's  
pintle. . .

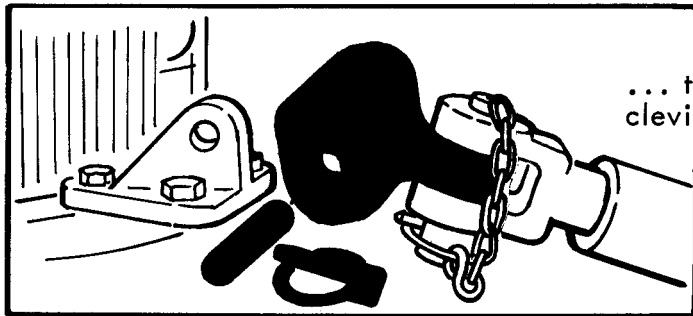
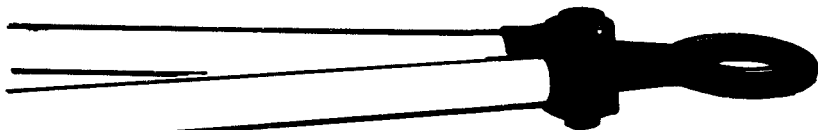
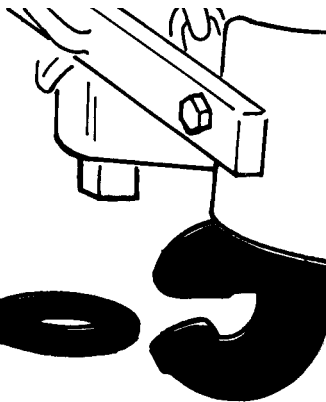

... then un-couple  
clevises from brackets.

Put all pins, etc., back in place before storing. You'll use less space if you slide the leg extensions completely in.

Replace un-used lifting shackles and pins if you had any on your disabled vehicle.

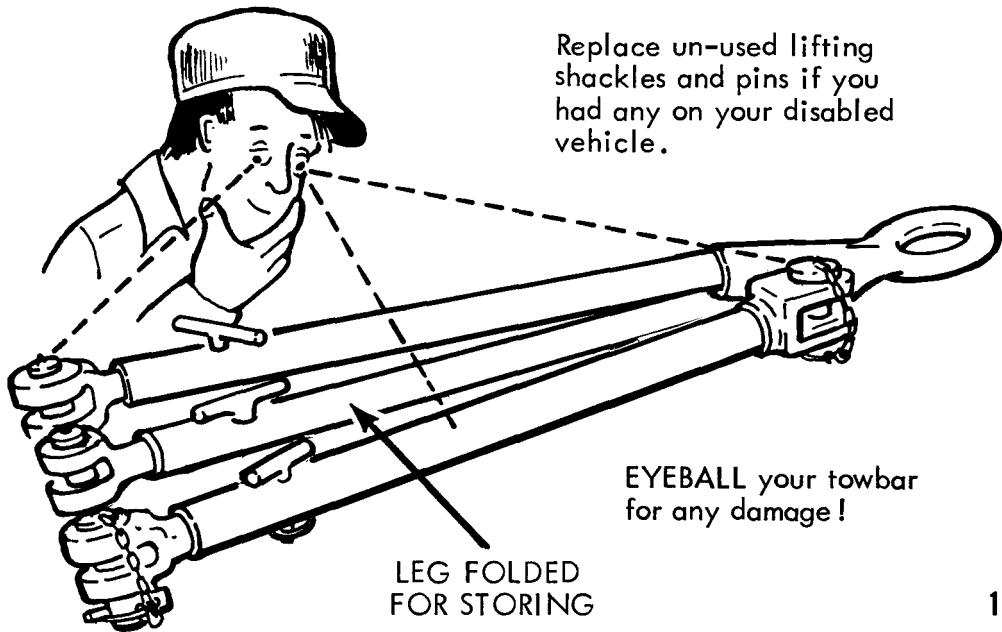

LEG FOLDED  
FOR STORING

EYEBALL your towbar  
for any damage!

# 2 LIFT-TOW OPERATIONS

If your disabled vehicle has NO towing brackets on its front bumper, or power steering, transmission, or front tires are someway inoperable, lift-tow using a wrecker (see FM 20-22, Para. 90 b.).



HERE'S WHAT YOU'LL DO IF TOWBAR IS USED FOR STABILIZATION:

1

LENGTH ADJUSTMENT PIN

Remove length adjustment pins from the towbar's legs...

SAFETY PIN

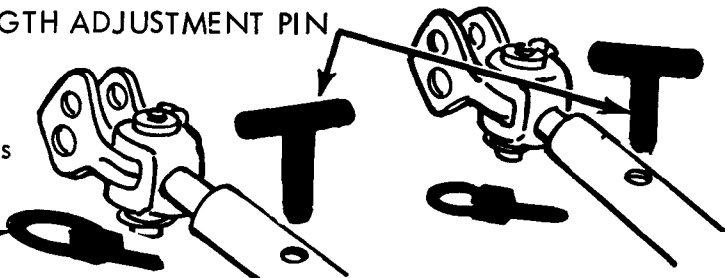

2

...and slide out leg extensions completely.

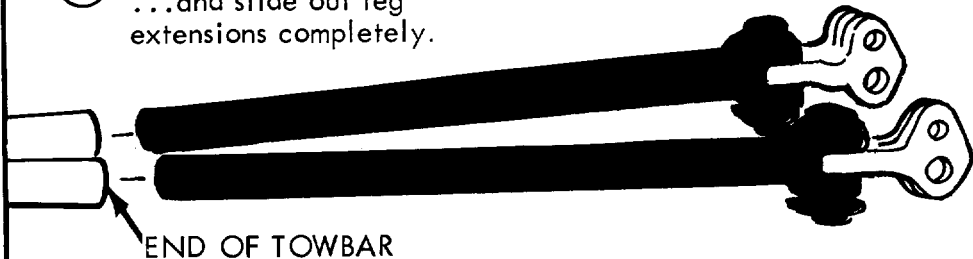

3

Now, attach clamps to clevis of each leg extension like this:



MORE   
19

- 4 When lift-towing, the LARGER linking pin is ALWAYS on the BOTTOM.

Rotate clevis 180° to change pin.

If everything looks O.K., you're ready to attach clamps and chains to axle.

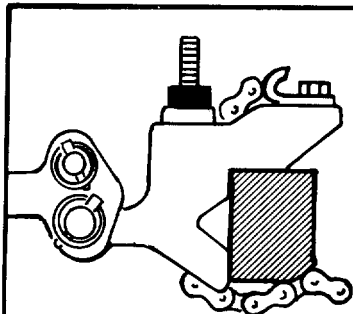
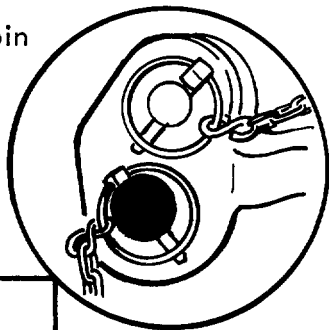

Clamp fits snugly against front of axle, with tension adjusting nut on TOP.

5

Loosen nut generously, but DON'T un-screw it completely.

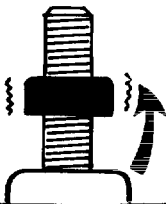

6

Now, pull chain around axle and up through clamp.

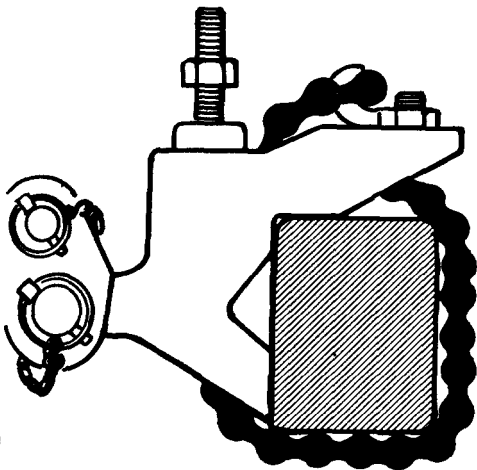

Pull it TIGHT and place it on hook.

7

Even you strongmen will now TIGHTEN the tension adjusting nuts with a WRENCH.

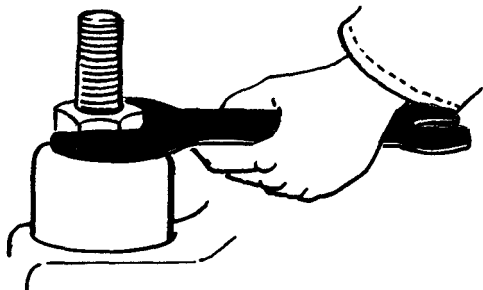

Make sure clamp and chain are firmly secured. A loose nut may allow them to work loose..

...THEN

8

When both clamps are secured, slide leg extensions back into legs as far as is necessary, and replace length adjustment pins, with top of "T" on TOP!

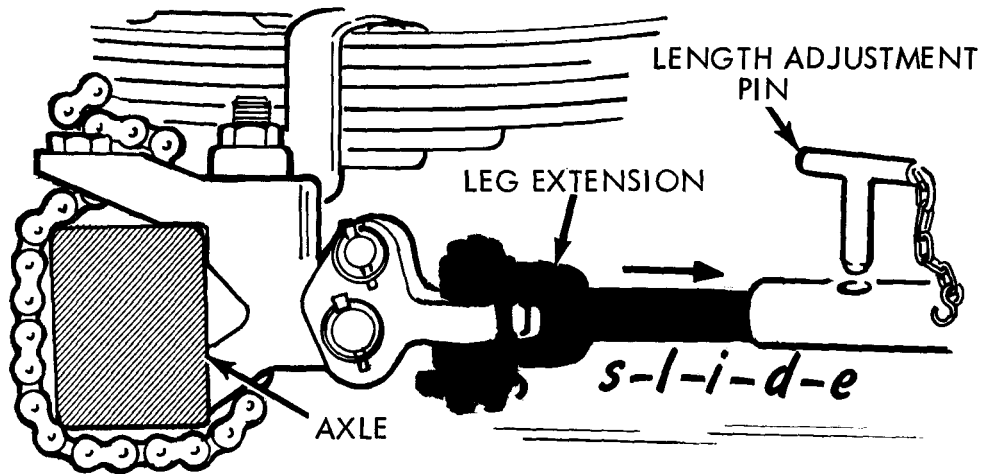

Keep LENGTH of TOWBAR as SHORT as you can.



## BE SAFE!

Check to see that all 9 safety pins are in place.

Now you're ready to attach towbar's lunette to tow truck's pintle. Back up the truck if necessary.

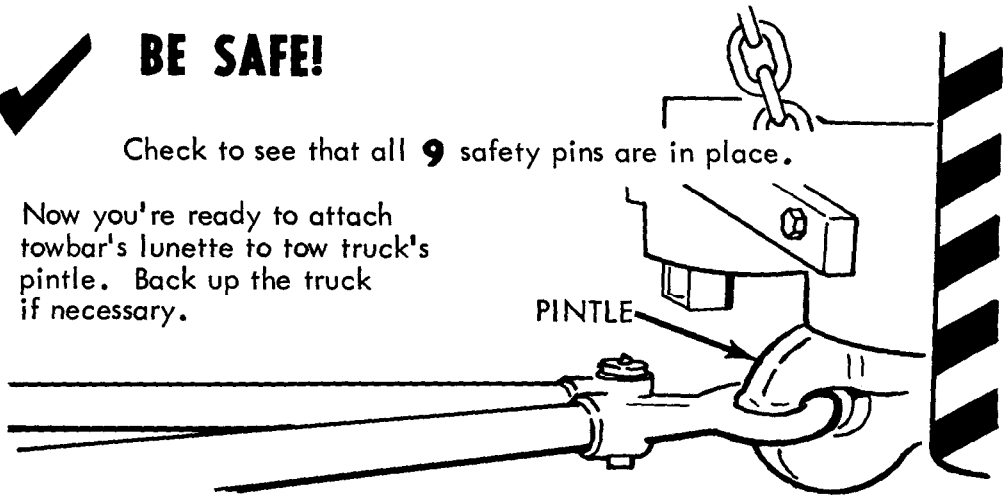

NOTE: When towing a vehicle by the axle, use a WINCH and HOOK along with the towbar, in order to raise the front wheels of the towed vehicle.

- ▶ Always completely attach towbar **FIRST** when using a winch with it.

MORE



TOWBAR BEING USED  
WITH HOOK AND WINCH

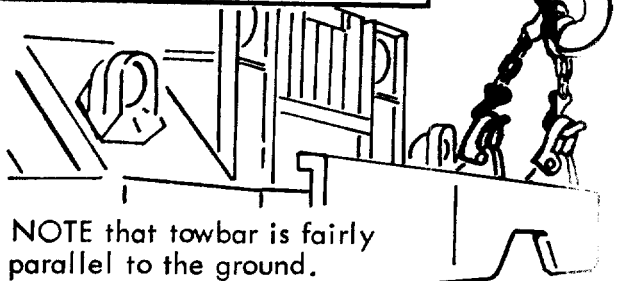

NOTE that towbar is fairly  
parallel to the ground.

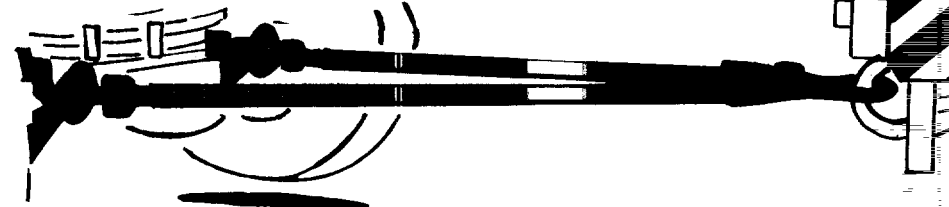

A BETTER TOW...

A set-up using both the TOWBAR and the WINCH offers

24 better maneuverability.

# When you're through:

- ① Lower towed vehicle to ground, remove hook and chains, then disconnect towbar from truck pintle.)

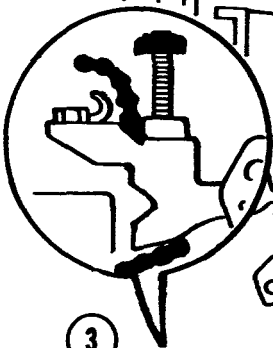

- ② Out come length adjustment pins and legs of towbar.

- ③ Screw off tension adjusting nuts generously and remove clamps and chains from axle.

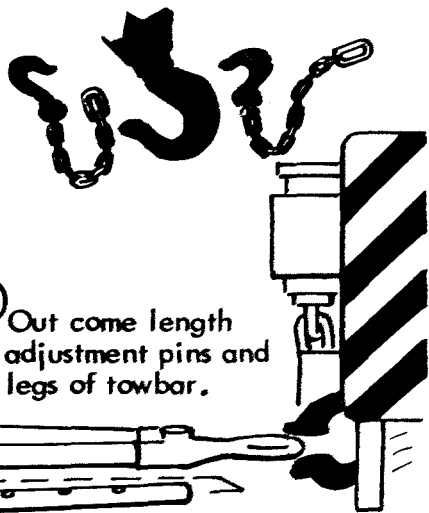

...NEXT ▶

4

Now slide leg extensions back in place and replace length adjustment pins.

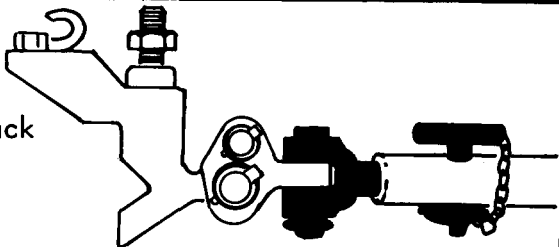

5

Finally, (whew!) remove clamps from towbar.

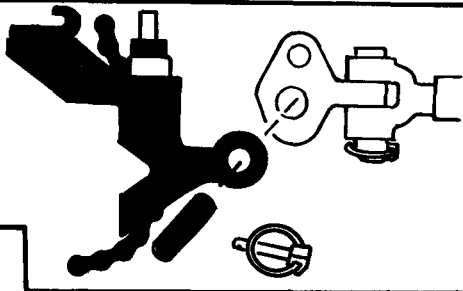

Make sure all pieces of towbar are back in place before storing!

**TOWING** can be **FUN!!**

# 3 BUMPER TOWING

If there are no towing shackle brackets on the disabled vehicle tow from the front bumper.

Follow the same procedures and precautions described in section 2 (lift-tow operations), EXCEPT you'll attach clamps and chains to bumper . . .

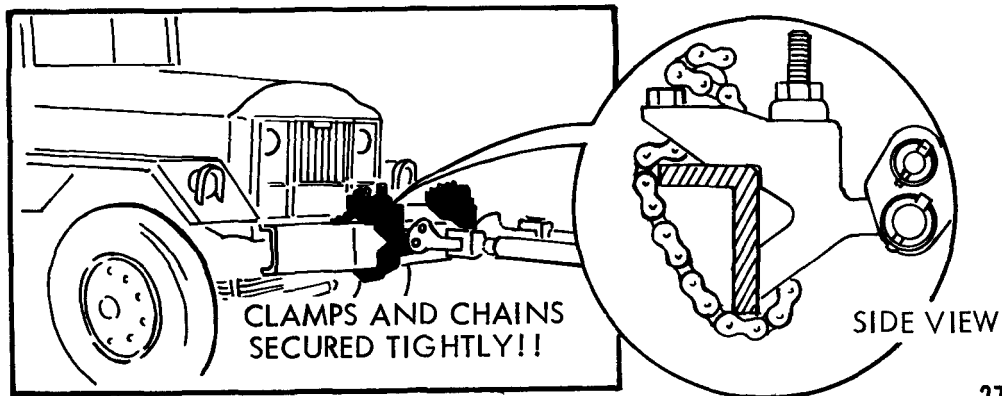

# LUBRICATION ?

Maybe a rub-down periodically to prevent and, a dab or two of general purpose oil around your various pins will make them easier to work with. Common sense is the guide here.

**RUSTING**

## A FINAL WORD .... **Safety!**

A sharply turned corner or a U-TURN can **CRACK** the legs of your TOWBAR! Take these kinds of turns **SLOWLY!** The vehicle you save...

**ANY OTHER TOWING RESTRICTIONS ARE IN YOUR VEHICLES' MANUALS.**

... ANY QUESTIONS??

HAVE A SUGGESTION MAYBE?

WE AIM TO PLEASE.

*Write to us.*



COMMANDING GENERAL  
U.S. ARMY WEAPONS COMMAND  
ATTN: AMSWE - MAS  
ROCK ISLAND, ILLINOIS 61201



# **TM 9-4910-496-10**

This TM supersedes TM 9-4910-496-10, December 1971, and DA Messages WECOM 262016Z, Jul 72 (U) and 241721Z, Oct 72 (U); Subject: Interim Change to TM 9-4910-496-10 for Towbar, Motor Vehicle, FSN 4910-735-6056.

**By Order of the Secretary of the Army:**

**CREIGHTON W. ABRAMS**  
*General, United States Army*  
*Chief of Staff*

**Official:**

**VERNE L. BOWERS**  
*Major General, United States Army*  
*The Adjutant General*

## **DISTRIBUTION:**

To be distributed in accordance with DA Form 12-21 (qty rqr block No. 132) Requirements for FSC Group 4910-IL.